

EL-PRESS

Digital Electronic Pressure Meters and Controllers

> Introduction

Bronkhorst High-Tech B.V. the European market leader in thermal Mass Flow Meters/Controllers and Electronic Pressure Controllers, has many years experience in designing and manufacturing precise and reliable measurement and control devices. With a wide range of instruments, Bronkhorst® offers innovative solutions for many different applications in many different markets.

The instruments are made to customers' specification, in various styles, suitable for use in laboratory, industrial and hazardous areas, in such diverse applications as semiconductor and analytical installations, to name but two.

> EL-PRESS series Pressure Meters and Controllers

The EL-PRESS series electronic Pressure Meters and Controllers have a well-proven compact thru-flow design and are available in pressure ranges from 2...100 mbar up to 8...400 bar, both in absolute and relative (gauge) pressure. A differential pressure transducer can also be supplied in the ranges of 2...100 mbar up to 0,3...15 bar. The pressure controller performs with high accuracy and repeatability and should be specified for forward or backward pressure control.

> State of the art digital design

Today's EL-PRESS series are equipped with a diaphragm type piezoresistive pressure sensor and a digital pc-board as standard and offer high accuracy, stability and reliability. The basic digital pc-board contains all of the general functions needed for measurement and control. In addition to the standard RS232 output, the instruments also offer analog I/O. As an option, an integrated inter-face board provides DeviceNet™, PROFIBUS DP, Modbus, EtherCAT®, PROFINET or FLOW-BUS protocols. The latter is a fieldbus based RS485, specifically designed by Bronkhorst High-Tech for their mass flow and pressure metering and control solutions, and with which the company already has over ten years of experience with digital communication.

> Pressure Controllers for every application

The control valve can be furnished as integral part of an EL-PRESS Pressure Controller (EPC), or as a separate component. It is a proportional, electromagnetic control valve with extremely fast and smooth control characteristics. With reference to the specific



field of application there are different series of control valves. There is a standard direct acting valve for common applications, a pilot operated valve for high flow rates, the so-called Vary-P valve that can cope with up to 400 bar ΔP and a bellows valve for applications with very low differential pressure.

> EL-PRESS features

- ◆ High accuracy and repeatability
- ◆ High pressure capability up to 400 bar
- ◆ Stable control even at varying process volumes
- ◆ Optional metal sealed and downported constructions
- ◆ Analog I/O signals: 0...5(10) V / 0(4)...20 mA
- ◆ Digital communication: RS232, DeviceNet™, PROFIBUS DP, Modbus-RTU/ASCII, EtherCAT®, PROFINET or FLOW-BUS

> Fields of application

- ◆ Semiconductor processing
- ◆ Gas and liquid chromatography
- ◆ Vapour pressure control in MOCVD processes
- ◆ Protective gas pressure control in extrusion moulding processes
- ◆ Autoclave / reactor pressure control

> Measuring principle

The Bronkhorst High-Tech EL-PRESS pressure sensor is a piezo-resistive bridge on the surface of a silicon chip. This chip is drilled out on its reverse side, giving the inside of the chip the form of a pressure diaphragm, whose thickness determines the pressure range. When a pressure acts on this chip, the diaphragm flexes, and the resistor values of the bridge alter in proportion to the pressure. The measuring cell is separated from the external pressure by a thin, sensitive stainless steel diaphragm, and the sealed off cavity between diaphragm and cell is filled with oil.

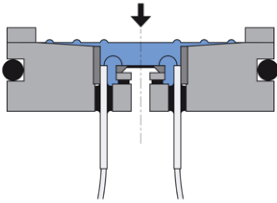

Cross sectional drawing of a pressure sensor



P-506C Differential Pressure Transducer

> Dimensional drawings

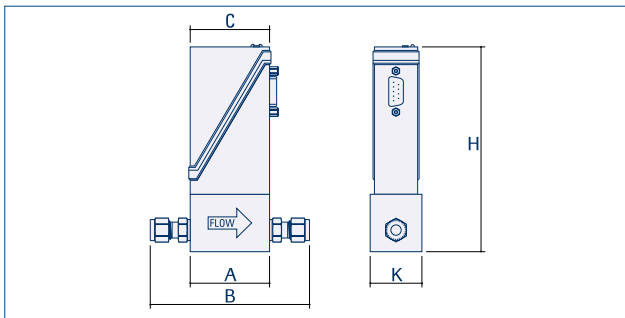

Pressure Meter

Model	A	B	C	H	K	Weight (kg)
P-502C/P-512C/P-522C/P-532C	47	97	47	123	30	0,4
P-502CM ¹⁾	87	124	47	128	29	0,6
P-506C	55	105	47	116	30	0,4

Dimensions in mm.

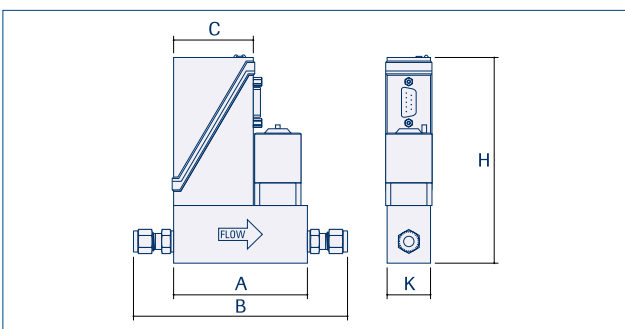

Forward Pressure Controller

Model	A	B	C	H	K	Weight (kg)
P-602CV/P-612CV	77	127	47	123	25	0,7
P-602CM ¹⁾	87	124	47	128	29	0,7

Dimensions in mm.

Back Pressure Controller

Model	A	B	C	H	K	Weight (kg)
P-702CV/P-712CV	77	127	47	123	25	0,7
P-702CM ¹⁾	87	124	47	128	29	0,7

Dimensions in mm.

¹⁾ with 1/4" face seal male connections

> Configurations

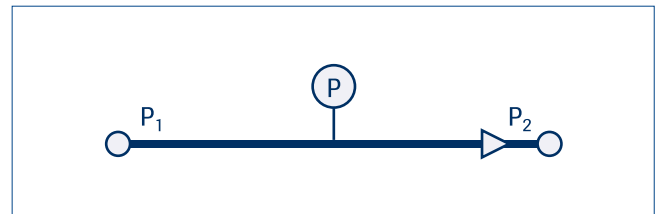

Pressure measurement

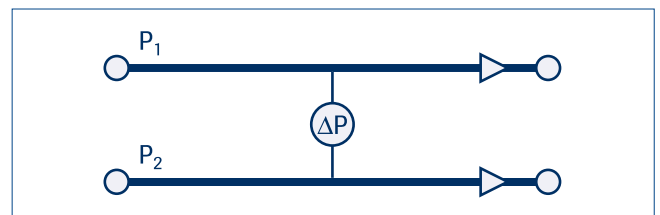

ΔP-measurement

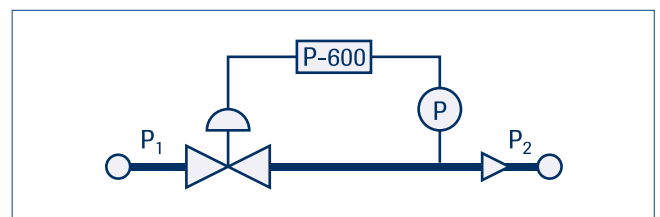

Forward pressure control

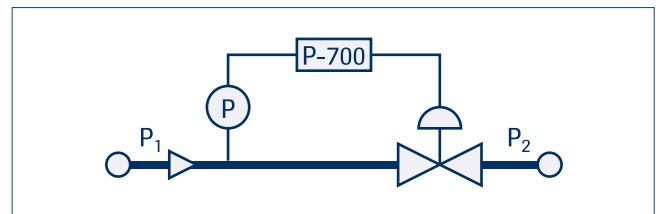

Back pressure control

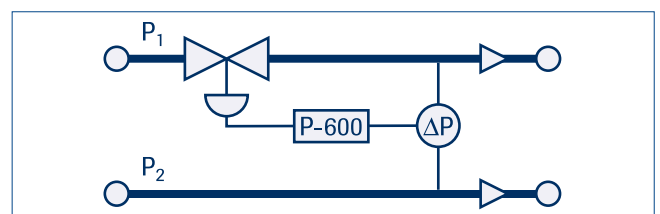

ΔP-control

> Examples of some applications

It is of course impossible to picture the possible number of applications. Here is a limited quantity of basic examples, which are often seen with some variations. However, identical or similar configurations are used in totally different applications. Therefore please consider the ones pictured here as examples for solving common applications.

> Pressure control combined with flow measurement

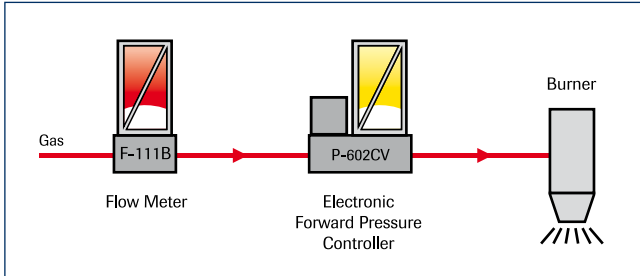

This arrangement of an EL-FLOW Mass Flow Meter with, in series, an EL-PRESS Forward Pressure Controller is used in burner test applications, or tests to check the inlet pressure dependence of the capacity of mechanical pressure regulators, or the tolerance on the bore of orifices, etc.

> Forward Pressure Control in G.C. (gas chromatography)

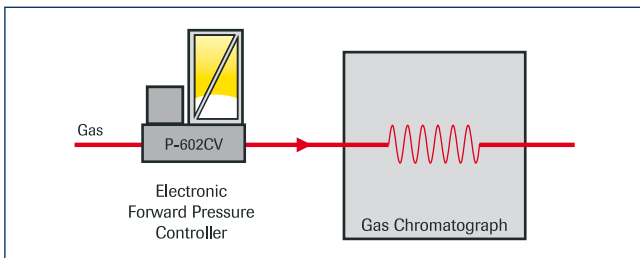

In Gas-Chromatography there is an increasing need to automate all required parameters. The EL-PRESS Forward Pressure Controller enables the user to select a desired pressure profile for the analyses, whereby the pressure is kept constant to a very precise value, even at very low flow rates.

> Pressure control with adjustable flow

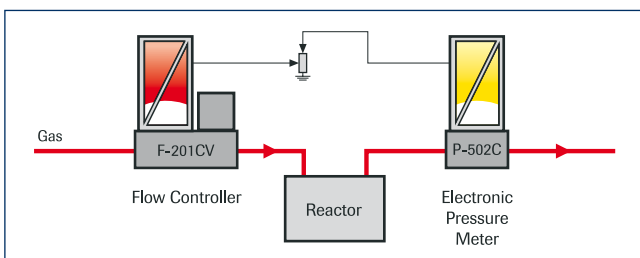

The control valve of the EL-FLOW F-201CV Mass Flow Controller (MFC) forms a closed loop pressure control system with the EL-PRESS P-502C Pressure Transducer: the Mass Flow Meter of the MFC measures the required flow rate to maintain the set pressure level. The setpoint voltage divider enables the user to adjust the maximum flow to build up desired pressure levels. Restriction of the maximum flow may for safety reasons be important in certain processes.

> Back pressure control independent of gas mix and total flow

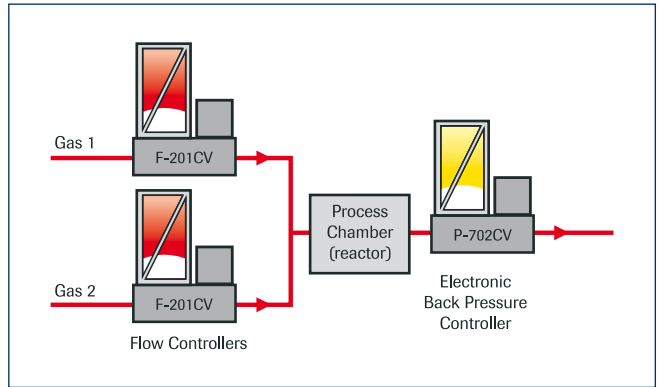

A gas mixture is formed by EL-FLOW Mass Flow Controllers. In a process chamber the effect of the catalyst on certain reactions is tested. The pressure in the process chamber is controlled to the desired level by means of an EL-PRESS Back Pressure Controller, independent of the total flow and/or the composition of the mixture.

> Compensation of atmospheric pressure changes

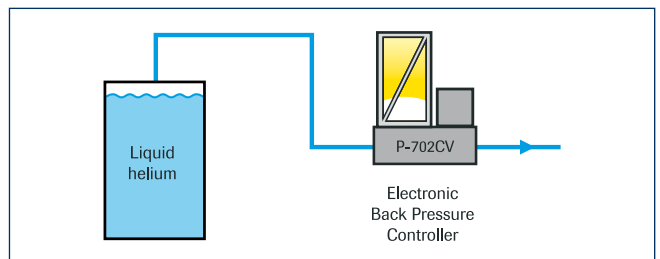

Superconducting coils, which are used to generate magnetic fields, are cooled by liquid helium. Depending on the temperature exchange gaseous helium should be vented. With a manually controlled outlet the variation of the atmospheric pressure disturbs the magnetic field. By using an EL-PRESS P-702CV Back Pressure Controller the pressure for the superconducting coils is kept constant, thus eliminating the negative effects of atmospheric pressure variations.



P-502C Pressure Meter with F-004AC bellows valve for low ΔP applications

> Technical specifications

Measurement / control system

Accuracy	: ±0,5% of full scale (FS)
(incl. linearity and hysteresis)	
Pressure rangeability	: Measurement: 1 : 50 (2 ...100%) Control (with flow range 1 : 50) P-602CV/P-602CM/P-612CV 1 : 20 P-702CV/P-702CM/P-712CV 1 : 5
Repeatability	: ≤ 0,1% RD
Response time sensor	: 2 msec
Control stability	: ≤ ±0,05% FS (typical for 1 l _r /min N ₂ at specified process volume)
Operating temperature	: -10...+70°C
Temperature sensitivity	: 0,1% FS/°C
Leak integrity	: tested < 2 x 10 ⁻⁹ mbar l/s He
Attitude sensitivity	: < 0,3 mbar (abs./rel. sensors); (at 90° change) < 6 mbar (dif. sensors)
Warm-up time	: negligible

Mechanical parts

Material (wetted parts)	: stainless steel 316L or comparable
Process connections	: compression type or face seal couplings
Seals	: standard: Viton® options: EPDM, FFKM (Kalrez®)
Ingress protection (housing)	: IP40

Electrical properties

Power supply	: +15...24 Vdc
Max. power consumption:	Supply at voltage I/O at current I/O
	Meter: 15 V 67 mA 90 mA
	24 V 49 mA 67 mA
	Controller: 15 V 200 mA 223 mA
	24 V 132 mA 150 mA
Extra for fieldbus:	PROFIBUS DP: add 53 mA (at 15 V) or 30 mA (at 24 V)
(if applicable)	PROFINET: add 77 mA (at 15 V) or 48 mA (at 24 V)
	EtherCAT®: add 66 mA (at 15 V) or 41 mA (at 24 V)
	DeviceNet™: add 48 mA (at 24 V)
Digital communication	
Standard (9-pin D-conn. male)	: RS232
By optional interface board	: PROFIBUS DP, DeviceNet™, EtherCAT®, FLOW-BUS, Modbus-RTU/ASCII, PROFINET
Electrical connection	
Analog/RS232	: 9-pin D-connector (male);
PROFIBUS DP	: bus: 9-pin D-connector (female); power: 9-pin D-connector (male);
DeviceNet™	: 5-pin M12-connector (male);
EtherCAT®/PROFINET	: 2x RJ45 modular jack (in/out)
FLOW-BUS/Modbus-RTU/ASCII	: RJ45 modular jack

Technical specifications and dimensions subject to change without notice.

> Models and pressure ranges

Electronic Pressure Transducers (EPT)

Models, elast. sealed	Pressure ranges
P-502C (absolute/relative)	min. 2...100 mbar max. 1,28...64 bar
P-512C (absolute/relative)	max. 2...100 bar
P-522C (absolute/relative)	max. 4...200 bar
P-532C (absolute/relative)	max. 8...400 bar
P-506C (differential)	min. 2...100 mbar max. 0,3...15 bar

Model, metal sealed

Model, metal sealed	Pressure ranges
P-502CM (absolute/relative)	min. 7...350 mbar max. 1,28...64 bar

Electronic Pressure Controllers (EPC)

Models, elast. sealed	Pressure ranges (abs/rel)
P-602CV ¹⁾ (forward pressure control)	min. 5...100 mbar max. 3,2...64 bar
P-612CV ¹⁾ (forward pressure control)	max. 5...100 bar
P-702CV ¹⁾ (back pressure control)	min. 20...100 mbar max. 12,8...64 bar
P-712CV ¹⁾ (back pressure control)	max. 20...100 bar

Models, metal sealed

Models, metal sealed	Pressure ranges (abs/rel)
P-602CM ¹⁾ (forward pressure control)	min. 17,5...350 mbar max. 3,2...64 bar
P-702CM ¹⁾ (back pressure control)	min. 70...350 mbar max. 12,8...64 bar

¹⁾ Kv-max = 6,6 x 10⁻²

For ranges of 200 or 400 bar rated pressure controllers and for low-ΔP control applications with Kv-values up to 1.0 please contact factory.

> Model number identification

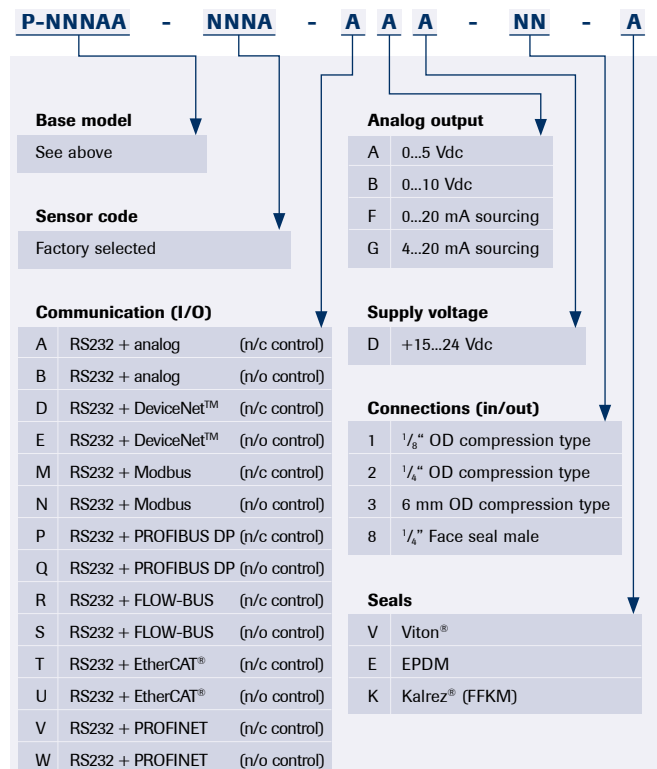

Bronkhorst®
HIGH-TECH

Bronkhorst High-Tech B.V. Nijverheidsstraat 1a, NL-7261 AK Ruurlo The Netherlands
T +31(0)573 45 88 00 F +31(0)573 45 88 08 I www.bronkhorst.com E info@bronkhorst.com

